

ART

ECOART

EcoArt transforms our signature eco-conscious material, ArtFelt, into striking art that blends style and sustainability. Designed to stand off the wall like a canvas, these ready-to-display creations add depth, dimension, and visual interest to any space.



SILHOUETTES

EcoArt offers designers a versatile decor solution that celebrates environmentally responsible design. Choose from one of our curated silhouettes or work with our designers to create a custom art piece.

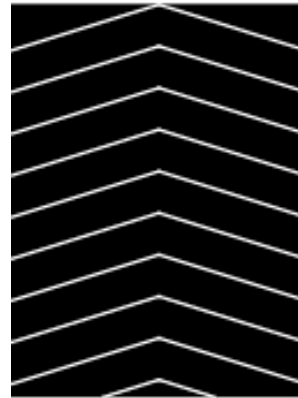

CHEVRON

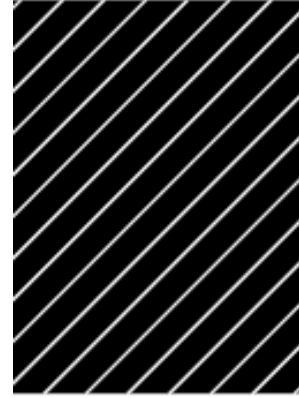

DIAGONAL

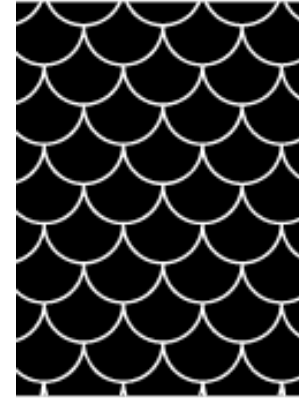

KOI

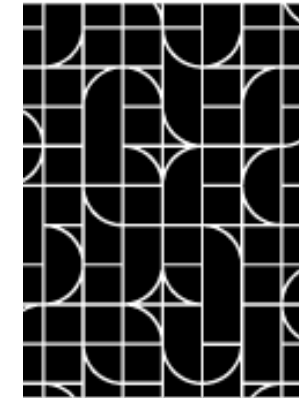

LUNAR

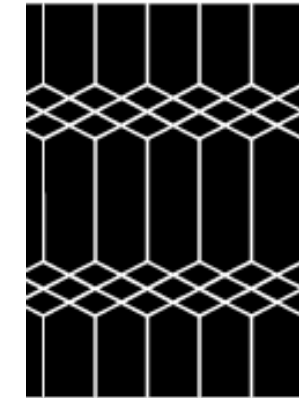

PRISM

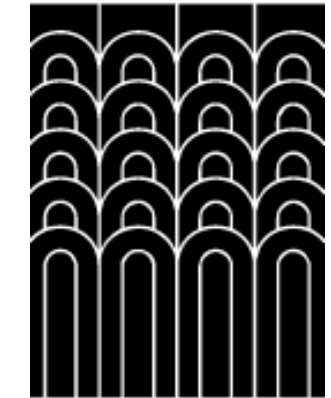

RAINBOW

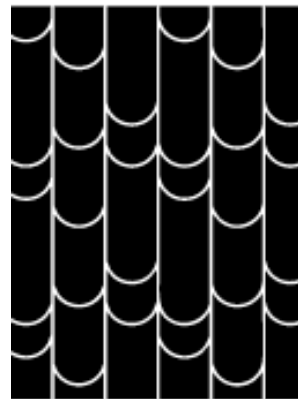

SCALLOP



ARRAY

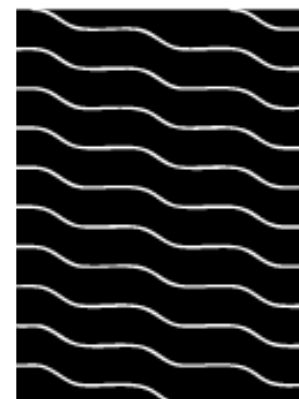

SLIDE

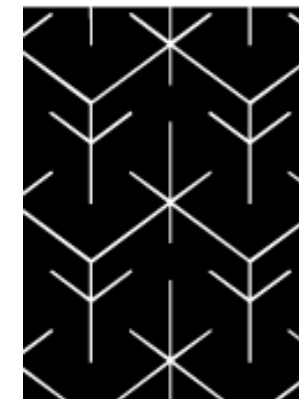

VERTEX



ZEN

COLOR GUIDE

9mm ArtFelt is the core material in our signature line of acoustic solutions.

Request samples to verify color as printers and monitors vary.

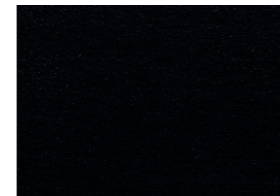

ECLIPSE

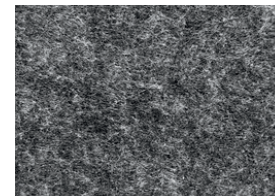

ASH



GRAPHITE



GREYSTONE



MIST

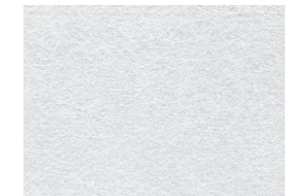

CRYSTAL



CASTLEWALL

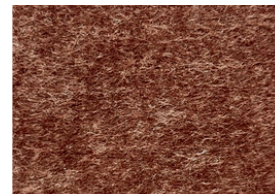

ESPRESSO



MOCHA



MOSS



SPRING

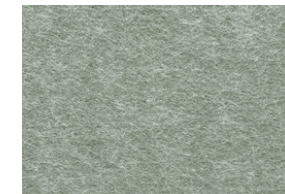

SAGE

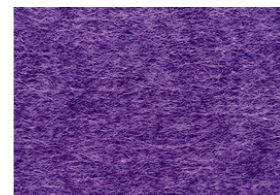

GRAPE

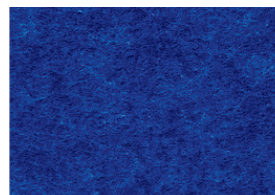

INDIGO

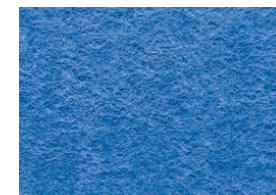

GLACIER



LAGOON



TROPICAL

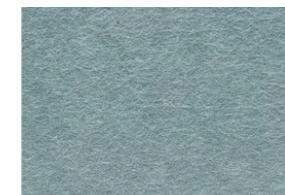

GALVANIZED

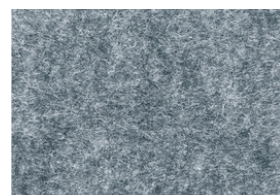

WEATHERED



VINTAGE INDIGO



MYSTIC

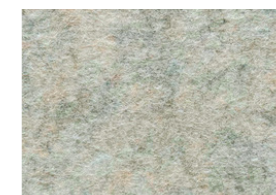

STONE



SANDSTONE



SEASHELL



CARDINAL



CITRUS



TANGERINE



SOLAR



LEMON



BIRCH



CEDAR

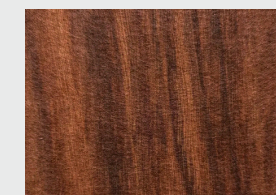

DARK OAK



DRIFTWOOD

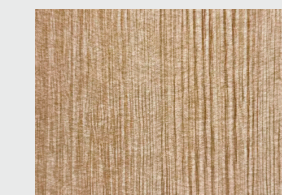

MAPLE

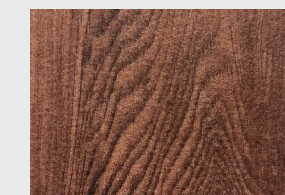

WEATHERED WALNUT

HOW TO SPECIFY

Whether you have a specific product in mind or desire to craft a fully customized soundscape, our team is ready to bring your vision to life!

1

CHOOSE YOUR SOUND SOLUTION

Looking to elevate how you address sound mitigation in your space? Explore our range of wall, ceiling, and screen solutions to begin shaping your ideal soundscape.

2

REFINE THE DESIGN

Once you've selected your application and product, it's time to refine the design. Dive into our array of silhouettes, textures, patterns, and colors to customize your creation.

3

SHARE YOUR VISION

Whether you already have a product and design in mind or require a fully custom solution, reach out to an ARTIZIN specialist or fill out the quote form on our website. A team member will walk you through each step of the process.

4

GIVE US THE LOWDOWN

It's beneficial if you can provide our team with architectural drawings, field measurements, design inspiration, or design intent.

INSTALLATION

Here's everything you'll need to get started.

Hardware

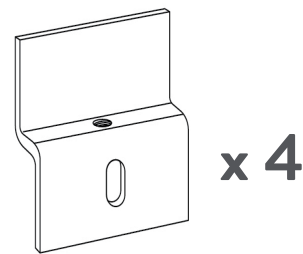

Z-Brackets

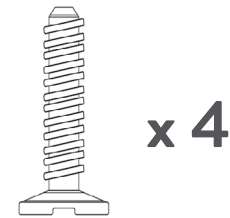

Flathead Screws

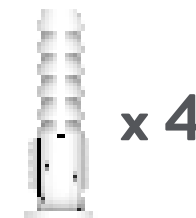

Anchors

Template (referenced in Steps 1 & 2)

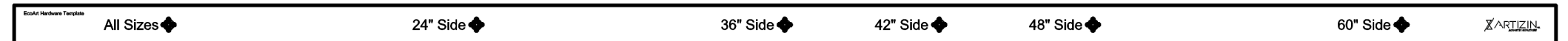

Chart (referenced in Step 3)

ECOART SIZE	LEFT TO RIGHT SPACING	TOP TO BOTTOM SPACING
	BRACKET 1 & BRACKET 2	
24"x36"	12" apart	32" apart
36"x24"	24" apart	20" apart
36"x48"	24" apart	44" apart
48"x36"	36" apart	32" apart
42"x60"	30" apart	56" apart
60"x42"	48" apart	38" apart

INSTALLATION

Stick to our straight forward installation guidance then kick back and revel in the acoustic paradise you've crafted.

NOTE: Ecoart can be hung like any other piece of art. To hang using the provided hardware, follow the steps below.

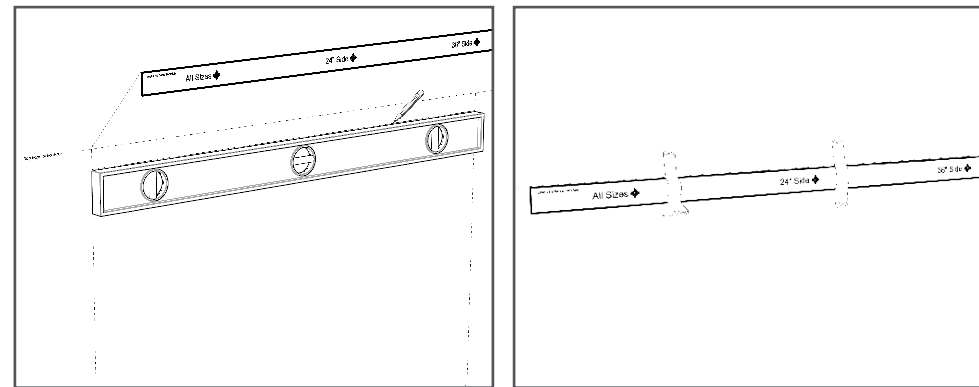

1. MARK PLACEMENT

- Lightly mark the wall where the top left and top right corners of your EcoArt will sit.
- Using a level, draw a light 10" horizontal line beginning at the top left mark and extending toward the center.
- Repeat this step beginning at the top right mark
- Align the top left corner of the provided template with the line and tape to the wall using nonaggressive painter's tape.
- Ensure the template aligns across the entire width the drawn line.
- Using the template, mark your top drill holes based on the EcoArt width.

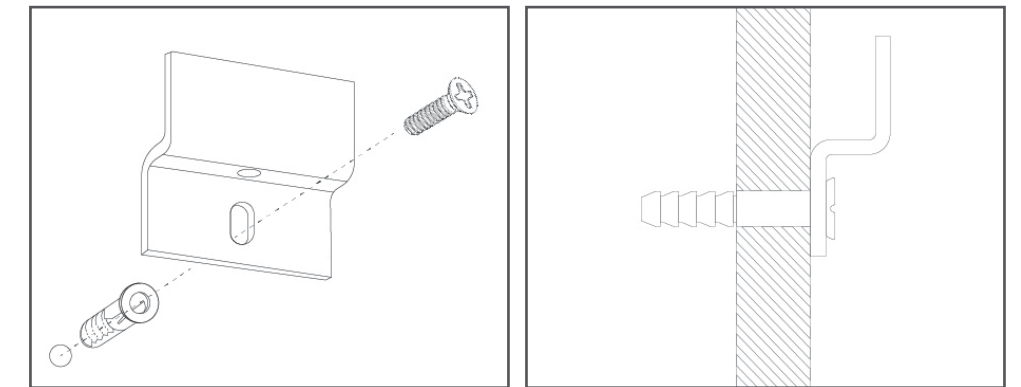

2. INSTALL TOP HARDWARE

- Remove the template from the wall.
- Drill two 1/4" holes where you made your marks.
- Insert the included plastic anchors into the holes.
- Using the provided flathead screws, secure the Z-Bracket hardware with the open end facing up.

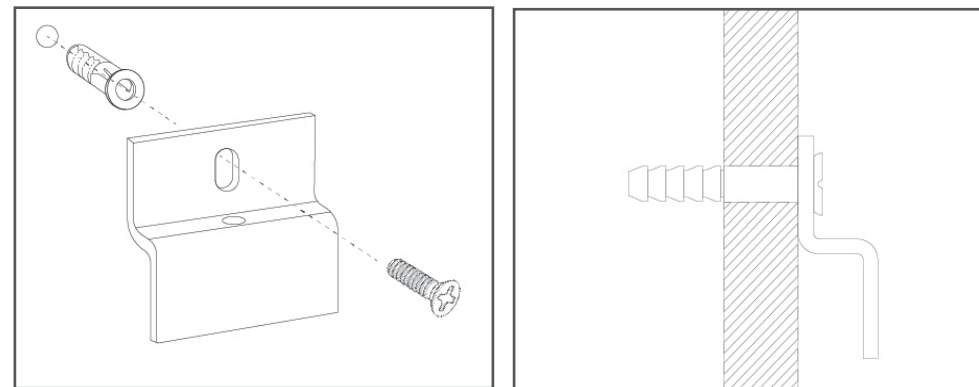

3. INSTALL BOTTOM HARDWARE

- Using the chart on page 5, measure the appropriate distance from the center of each top hole and mark where the bottom holes will be drilled.
- Use the provided template to double check the bottom drill marks are the correct horizontal distance apart.
- Drill two 1/4" holes at the marked locations directly below the top holes.
- Using the provided flathead screws, secure the Z-Bracket hardware with the open end facing down.

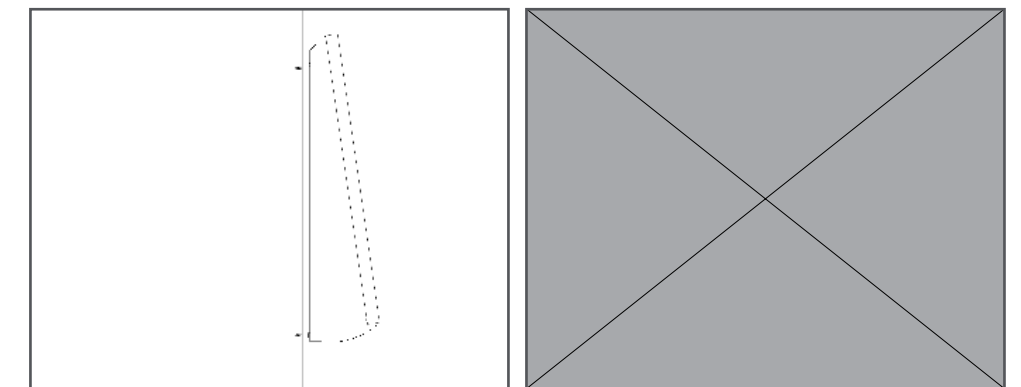

4. HANG THE ECOART

- Hang the top edge of the EcoArt on the top Z-brackets
- Align bottom brackets with cut out slots on the back of EcoArt
- Slide right to secure your EcoArt on the wall

YOUR ECOART IS NOW SECURELY INSTALLED!

SPECIFICATIONS

The details make all the difference. Dive into The specifics that contribute to the overall quality and functionality of our products.

APPLICATION	Wall
MATERIAL	9mm ArtFelt
COMPOSITION	60% Recycled Polyester Fiber, 40% Virgin Fiber
DIMENSIONS	18"x24", 24"x32", 36"x48", 40x54"
DENSITY	2000g/m2
FORMALDEHYDE EMISSION	0.00ug/g
NRC RATING	0.30
FIRE TEST ASTM E 84-ISAN	Class A
SUSTAINABILITY	Recyclable, Certified Clean Air Gold by Intertek Sustainability
WARRANTY	5 Year Limited Warranty
SAFETY	DECLARE, Red List Free

GENERAL CARE

Vacuum as needed to remove dirt and dust. Use an air compressor for hard to reach areas.

STAIN REMOVAL

Blot spills and spots immediately with a clean, soft white dry cloth (do not use paper products). Avoid using solvents or concentrated abrasives to clean ArtFelt. Always test in an inconspicuous area first.

MILD STAIN REMOVAL

Blot ArtFelt with a clean, soft white cloth dampened with a mild solution of soap and warm water. Repeat using only clean water (no soap) to remove soap concentrate. Pat dry with a lint free cloth.

CHALLENGING STAIN REMOVAL

Blot ArtFelt with a clean, soft white cloth dampened with a mixed solution of household bleach and water (70% bleach | 90% water). Repeat using only clean water (no bleach) to remove bleach concentration. Pat dry with a lint free cloth.



CUSTOM

Connect with our team to design a fully custom solution. Through meticulous prototyping and the expertise of our skilled designers, we'll transform your vision into a tangible, personalized creation. Whether you're seeking intricate patterns, unique textures, or custom colors, we're here to translate ideas into inspired designs.